

OMNI 5''

Dodecahedral sound source



Table of contents

Tested Source	3
Measuring environment	4
Measuring equipment	6
Results	7
Sound power	7
Sound pressure	8
Directivity	9

This paper shows the results of the measurements done to assess the compliance of the sound sources with the requirements stated in **ISO Standards 3744 and 3382** about sound power and directivity of sound sources.

The entire measurement was conducted following the guidelines provided by the International Standard Organisation about this kind of tests, in particular the procedure is compliant with **ISO Standard 17025**.

Tested Source

Model	Diameter (mm)	Weight (Kg)	Impedance (ohm)	Number of speakers
Omni 5" Dodecahedral sound source	350	12.5	3 + 3	12

The sound source was fed with Pink Noise using an AMG Mini Digital Amplifier.

During the measurement the sound source was installed on a rotating device (MB01) free to move on its central axis for 360° (see Fig. 1).

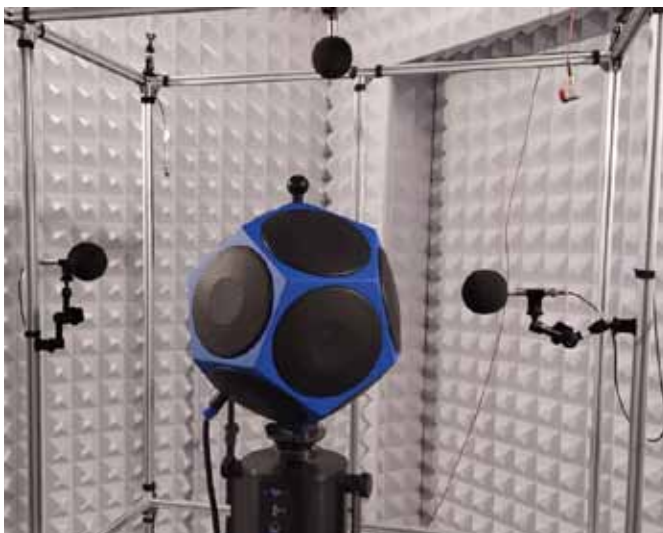

Fig. 1 Photos of measured source and measurement conditions

Measuring environment

Type	Temperature	Humidity	Pressure
Hemi-Anechoic Chamber	$23 \pm 1 \text{ } ^\circ\text{C}$	$30 \pm 15 \text{ } \%$	$994 \pm 10 \text{ hPa}$

In *Figure 2* is reported a simple drawing of the anechoic chamber used for this measurement. The height of the chamber is 2.63 m.

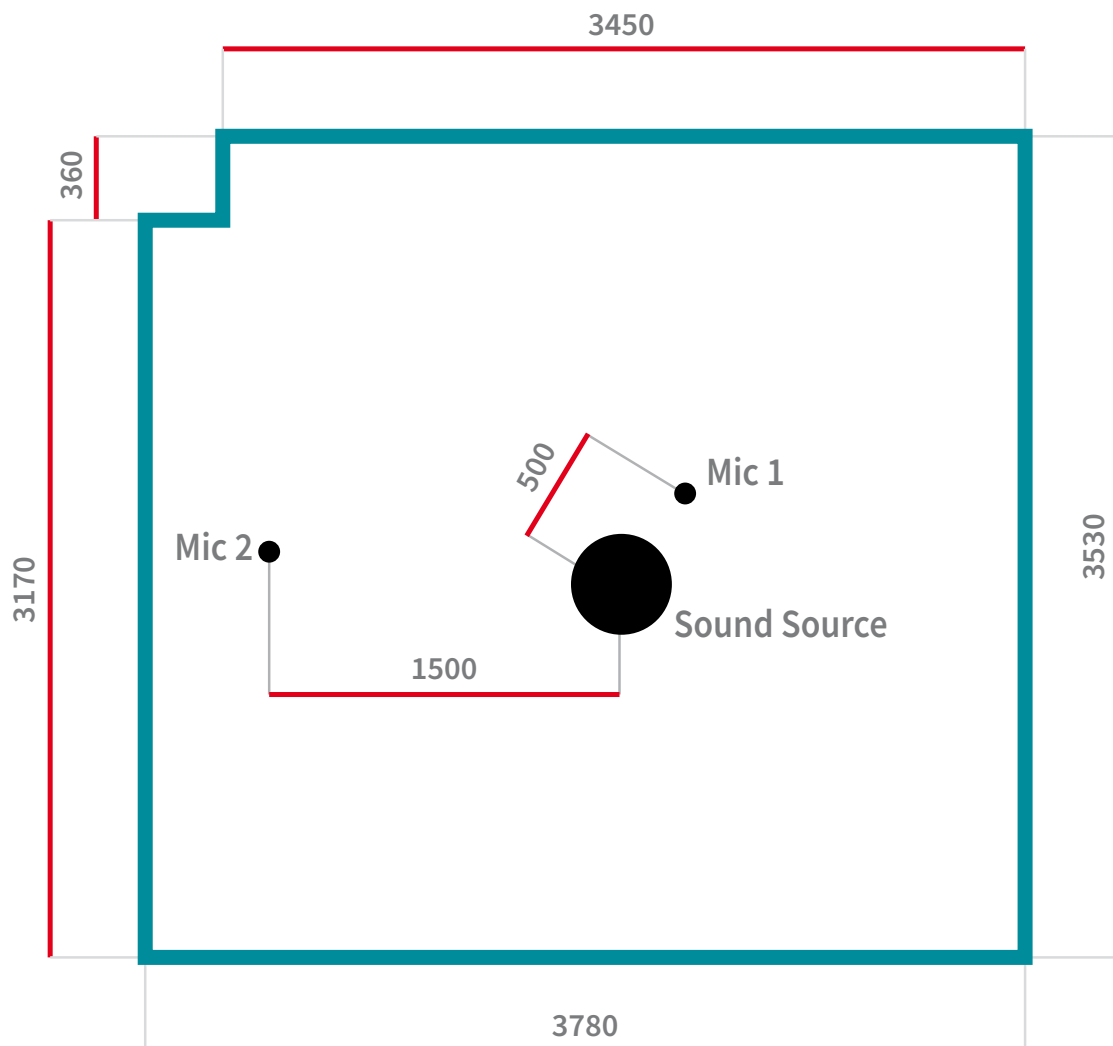

Fig. 2 Mic placement – Mic 1 is for sound power measurement, while Mic 2 is for sound pressure one. Distances in mm

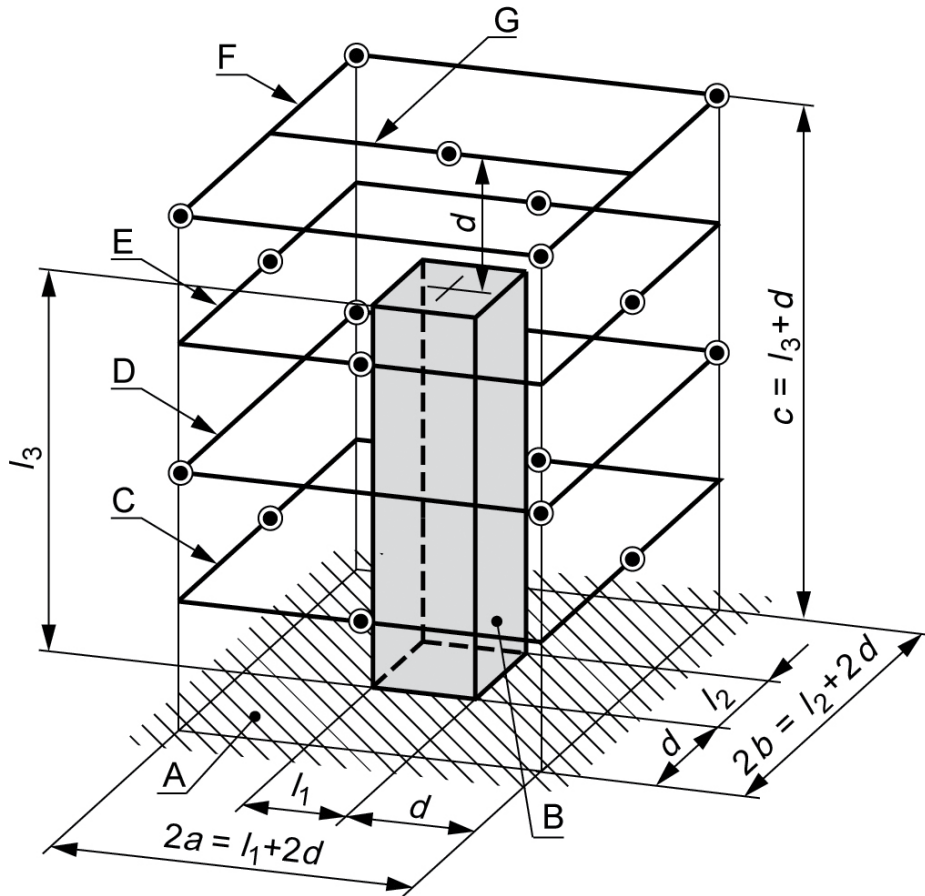

Fig. 3 Representation of measurement procedure as indicated in ISO 3744

The chosen procedure was the one of a high machine with a narrow base due to the assembly of the sound source (see Source Tested for a reference).

The next tables show the values of L1, L2, L3 and D for this speaker and, hence, the values of A, B, C and S.

L1 (m)	L2 (m)	L3 (m)	D (m)
0.35	0.35	1.77	0.5

A (m)	B (m)	C (m)	S (m ²)
0.675	0.675	2.27	14.0805

K1 and K2 correction factor are negligible because of the environment of the measurement (hemi-anechoic chamber).

Measuring equipment

Device	Model	Manufacturer	Serial number
Sound level meter	NL-52	Rion	00342833
Microphone	UC59	Rion	12852
Preamplifier	NH-25	Rion	10461
Sound Calibrator	NC-75	Rion	34891821
Rotating device	MB-01	Ntek	Ntek Calibration Lab test tool

The microphone used for the measurement was equipped with a windscreen.

To measure the sound source the Rotating device was used in order to “sample” the source every 5° as stated within the ISO Standard.

The microphone was left in the same position for the entire duration of the measurement.

The data acquired was, then, processed with the help of a dedicated software that, with a proper algorithm, led to the results indicated in *Results* section.

Results

In this section are reported the results of the measurements about the sound power of the source and its directivity.

Sound power

$L_w = 127.0$ dBA

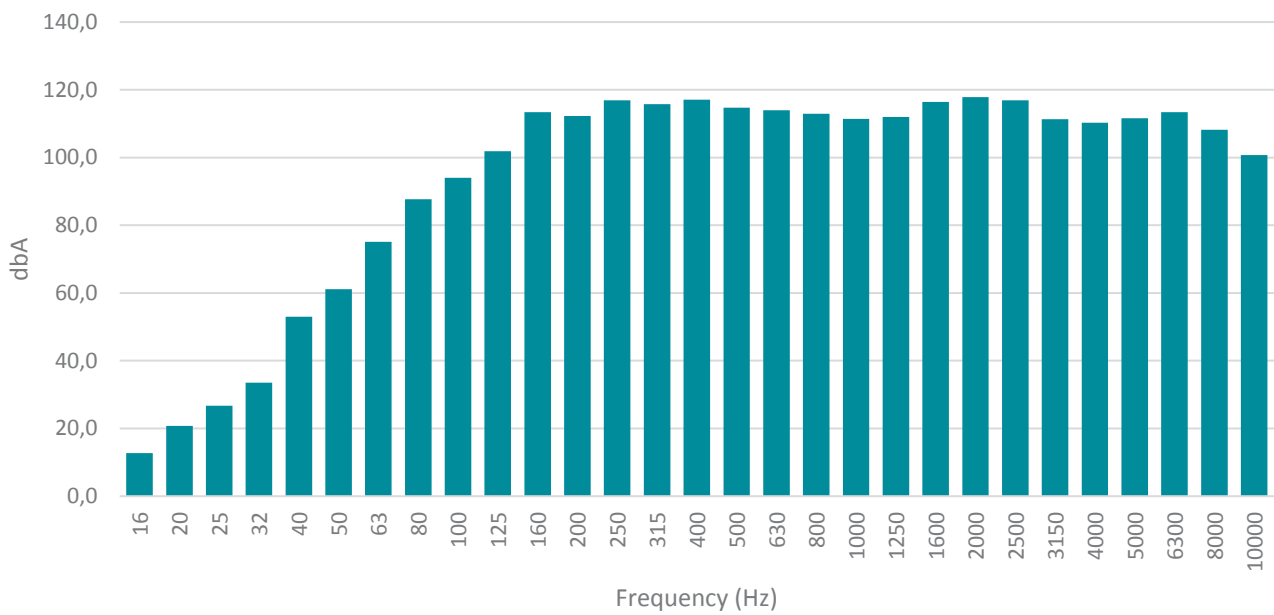

Fig. 4 Sound Power Level Spectrum - 1/3 oct

Sound pressure

Lp linear: 121 dB

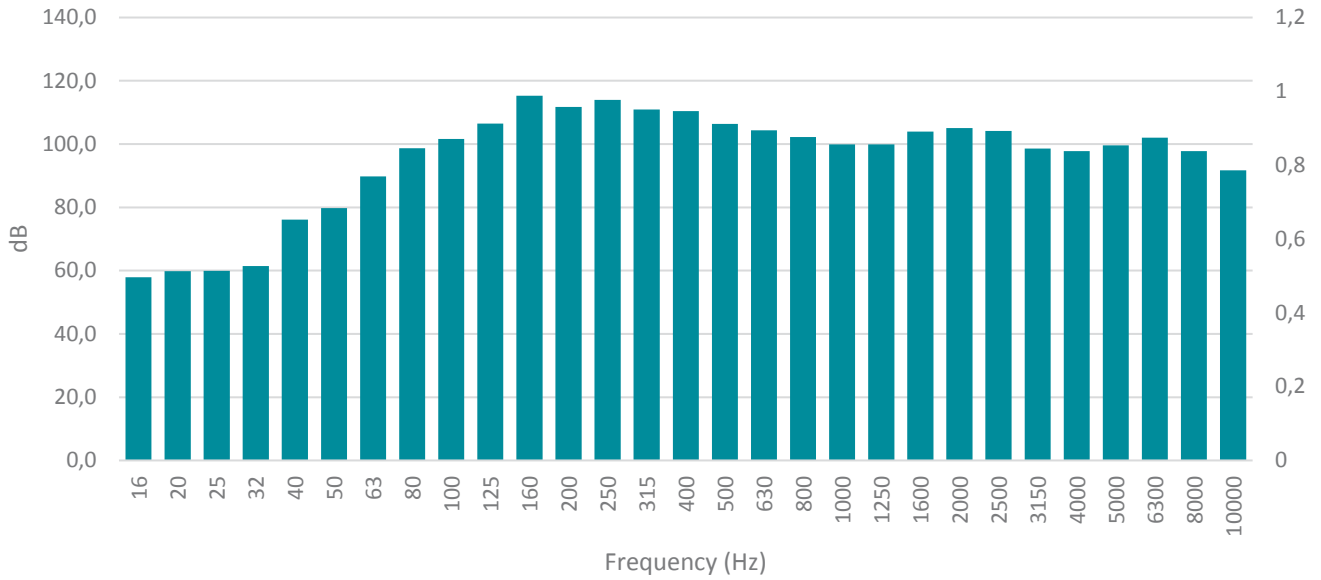

Fig. 5 Linear Sound Pressure Level – 1/3 octave

Lp: 116 dBA

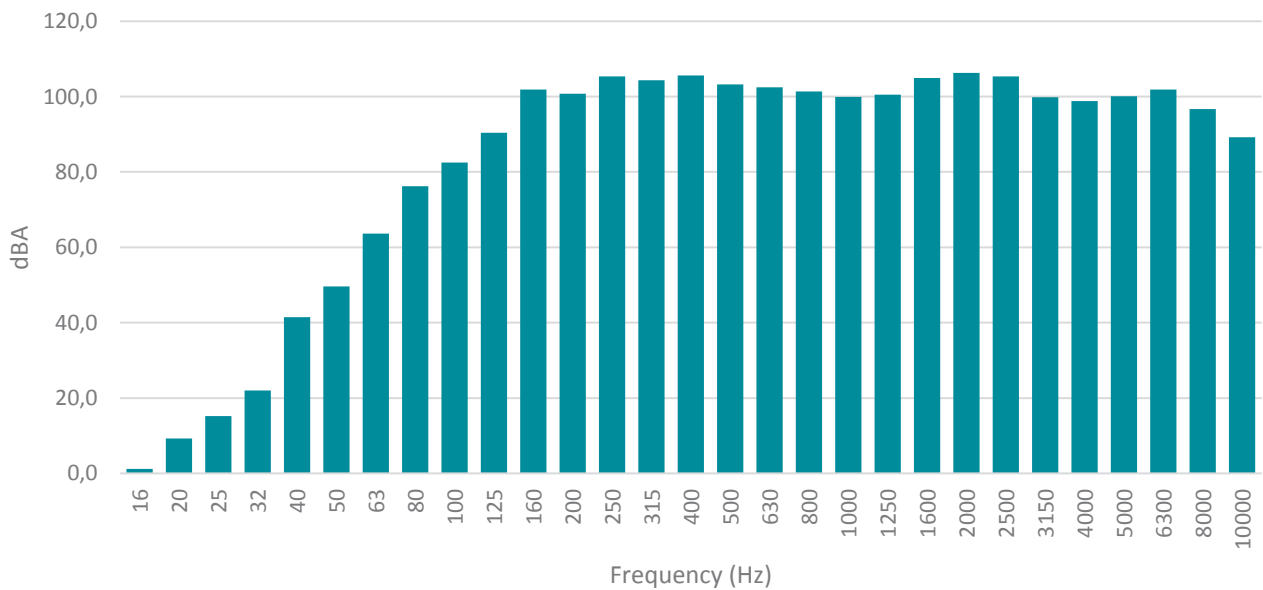

Fig. 6 A Weighted Sound Pressure Level – 1/3 octave

Directivity

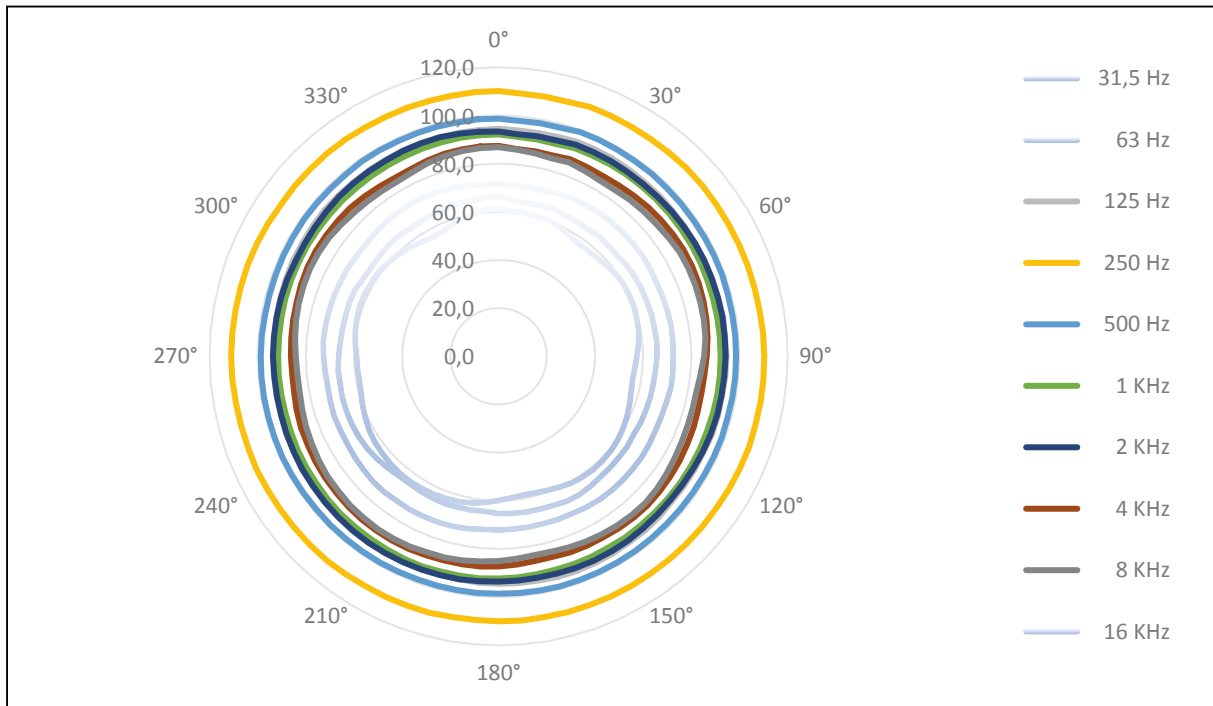

Fig. 7 Directional response - 1/1 octave

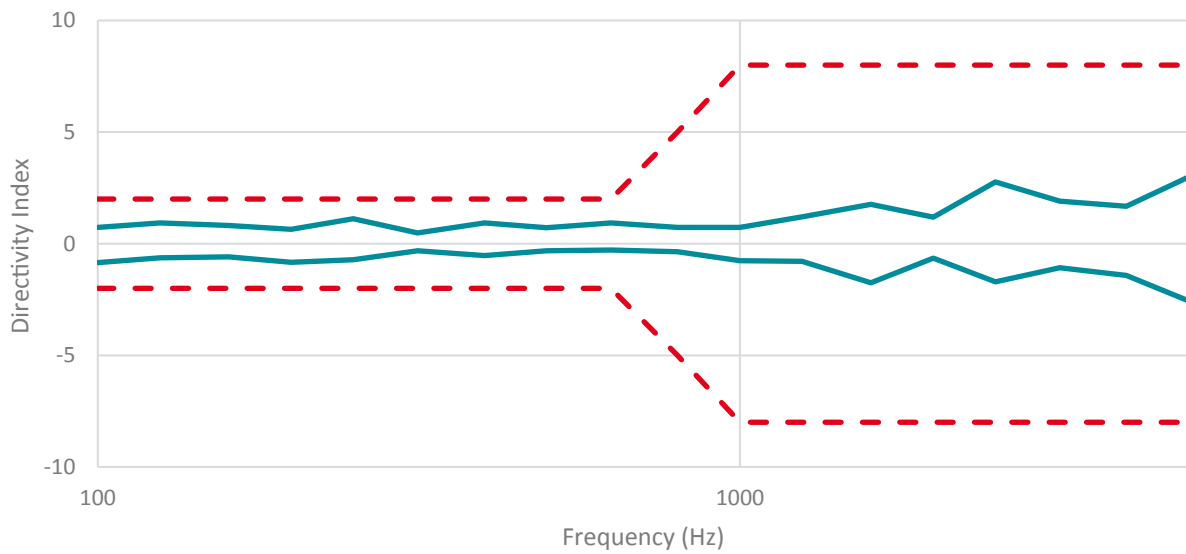

Fig. 8 Directivity according to ISO 16283. Upper and lower curves are the ISO 16283 tolerances

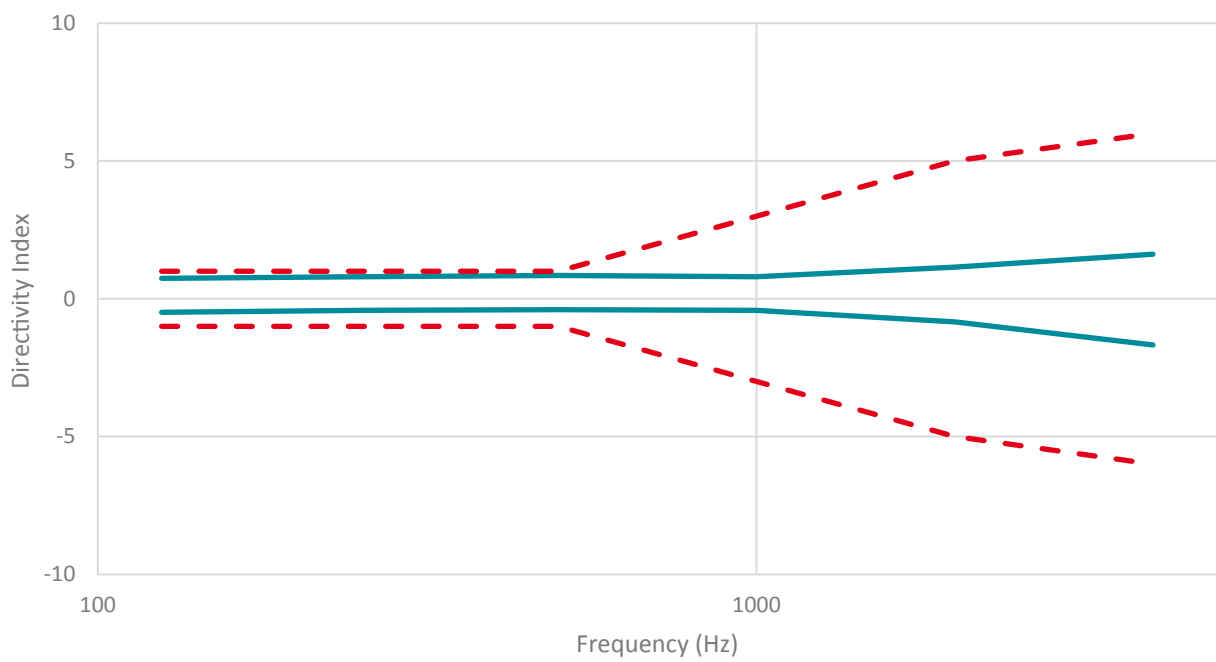

Fig. 9 Directivity according to ISO 3382. Upper and lower curves are the ISO 3382 tolerances

COMPANY IDENTITY

Ntek is specialized in products and services for noise and vibration measurement and control, in all applicable acoustic fields.

The company has been able to improve in designing, developing and producing solutions that mix simplicity, portability and user-friendly products with excellent quality.

Ntek main goal is to supply a qualified service with a complete range of products delivered on time in order to guarantee its customers the chance to focus on their business.

To keep this promise we have strongly invested in innovation and production process with monitoring procedures certified by independent primary authority.

OUR VISION

We believe that acoustics is the basis of wellness and improvement of life quality.

It's for this reason that we develop, innovate and produce equipment inspired to this philosophy.

HOW WE WORK

Ntek can ensure a high level of service, thanks to modern processes and new laboratories, completely equipped for different operations of design, production, measurement, check and control.

INTERNAL LOGISTICS AND STOCK

With its new operative location of 500 m² and its internal stock, Ntek guarantees available products in a short time according to customers' needs. Today we can handle an order in 48 hours compared with a standard delivery of 45/60 days.

The new location is structured to be flexible with logistics activities and in answering efficiently to productive needs of our customers.

SUSTAINABILITY

Green company, environmentally friendly, aimed to a continuous improvement of quality and safety in industrial processes.

Ntek S.r.l.

Via Gabrielli 18
10077 San Maurizio Canavese (TO)
ITALY
www.ntek.it
info@ntek.it
+39 011 40 53 600

